









OneStim

Not available for sale in USA



CE
2797

Item	Description	Picture	Price
------	-------------	---------	-------

OneStim

Order No: MP4011-XX			P.O.A
MP4011-XX	OneStim-CRM Cardiac Stimulator		P.O.A
MP4075-2B	Patient Connection Box 2CH		P.O.A
MP4108	ECG Cable, 5 lead Integrated IEC 5m		P.O.A
MP4105	ECG Cable, 10 Lead Integrated IEC		P.O.A
MP4118	POAG Equipotential Grounding Cable max 0.5A 5.0m		P.O.A
MP4002	DC Power Supply, 18V 3.4A, medical grade 1.5m		P.O.A
MP3059-XX XX: EU, UK, IT, SW	4x Mains Cables (EU, UK, IT, SW type) 2m		P.O.A
MP4006-CRM	User Instruction Manual		P.O.A

Configuration Options



Order No.	Description	Console	Channels	Price
MP5001-2PA	Two Channel for CSP Procedures	MP4011-2BC	2 Channel MP4075-2B	P.O.A
MP5000-2EP	Two channel for EP Laboratory Stimulation	MP4011-2BE		P.O.A
MP5002-4MI	Four Channel for Mini EP Procedures	MP4011-4BM	4 Channel MP4075-4B	P.O.A
MP5003-4CO	Switchable Mini-EP, EP & CSP configuration	MP4011-4BM		P.O.A



OneStim

Item	Description	Picture	Price
------	-------------	---------	-------

Optional Components

MP4085	4 Channel Unipolar Reference Adaptor Cable		P.O.A
MP4136	Equipotential Grounding Cable 2.5M		P.O.A
MP4009	Carrying Case		P.O.A
MP4003	SIP/SOP Cable Adaptor		P.O.A
MP3058	Circuit Continuity Test Led		P.O.A
MP4138	HDMI Male to HDMI/DVI Male Cable 5M		P.O.A
MP4140	HDMI Male to HDMI/DVI Male Cable 10M		P.O.A



EPS320B/BT

Item	Description	Picture	Price
------	-------------	---------	-------

EPS320BT - Standard Touch System

MP3102BT-B-XX	Stimulator carton with Stimulus Generator Unit, 2 output channels, Bona Light PC, accessories and Software Ver 4.0, with extra stimulus extension cable		P.O.A
MP3113-XX	Touch screen		P.O.A

EPS320B Custom Variances

MP3102B-XX	Base Configuration: Stimulator carton with Stimulus Generator Unit, 2 output channels, Bona Light PC, accessories and Software Ver 4.0		P.O.A
MP3076	NEC Non Touch Monitor		
MP3102BT-GE-XX	High End Configuration: Stimulator carton with Stimulus Generator Unit, 4 output channels, Bona Light PC, accessories and Software Ver 4.0, with extra stimulus extension cable & extended SM box cable.		P.O.A
MP3113-XX	Touch screen		
MP3102B-US-J	Japanese variants of MP3102		P.O.A



StimLab

Item	Description	Picture	Price
------	-------------	---------	-------

StimLab - 4 Packages

MP3171	StimLab Computer Cabinet Package pre-connected with MP3169-03 LCD and keyboard bundle 3meters & MP3164-17 StimLab remote cable 17meters		P.O.A
MP3172	StimLab & StimCor SGU Package with MP3008 stimulus generator unit MP3070-17 stimulus extension cable 17meters and MP3090 SM-Box control cable 15meters		P.O.A
MP3173	StimLab Remote Touch Screen Package pre-connected with MP3163 StimLab remote cable 4meters.		P.O.A
MP3174	StimLab Local Touch Screen Package		P.O.A

* Note refer to Optional Kits for ordering Roll Stand (MP3183)

StimLab Custom Variances / Options

MP3140	StimLab system contains 4 packages - which includes MP3171 MP3172 MP3173 MP3174		P.O.A
--------	---	--	-------



StimCor





Item	Description	Picture	Price
------	-------------	---------	-------

StimCor - 3 Packages

MP3343	StimCor Computer Cabinet universal configured Pre-Connected with MP3353-03 LCD & Keyboard Cable Bundle 3meter		P.O.A
MP3344	StimCor SGU Package 2 Chan with MP3008 stimulus generator unit, MP3070-13 stimulus extension cable 13meters and MP3014 2 Channel stimulus extension box For 4 Chan, order MP3172 (StimLab SGU)		P.O.A
MP3113-X	Touch Screen X = B for Bard and other distributors X = GE for GE		P.O.A

Optional Kits



Item	Description	Suitable for				Picture	Price
Touch Screen		EP	SL	SC	OR		
MP3113-X	Touch screen X = B for BSC and others X = GE for GE	X					P.O.A
MP3174	Local Touch screen		X				P.O.A

StimLab Upgrade Systems		EP	SL	SC	OR		
MP3385	StimLab upgrade system for EPS320BT (with Touch Screen) MP3171 MP3173 MP3386 MP3016	X					P.O.A

Optional Kits

Item	Description	Suitable for				Picture	Price
StimLab Roll Stand		EP	SL	SC	OR		
MP3183	Optional Stimlab roll stand package		X				P.O.A
10m LCD Cable Bundle Kit		EP	SL	SC	OR		
MP3403 Kit	StimCor Local LCD, Keyboard, Power & Sound Cable Bundle - 10 Metre & PC & LCD 13VDC Power Supply			X			P.O.A
MP3169-10 Kit	StimLab Local LCD, Keyboard, Power & Sound Cable Bundle - 10 Metre & PC & LCD		X				P.O.A
Compact Numeric Keypad		EP	SL	SC	OR		
MP3393	Compact Numeric Keypad	X	X	X			P.O.A
Four Channel Stimulus Multiplexer Kit		EP	SL	SC	OR		
MP3091	Four Channel Stimulus Multiplexer Kit	X		X			P.O.A
MP3091L	with extra SM Box 15m Control cable	X		X	X		P.O.A

Optional Kits

Item	Description	Suitable for				Picture	Price
Cable Kit		EP	SL	SC	OR		
MP3070-08 MP3070-13 MP3070-17	Ultra Low Capacitance Stimulus Extension Cable - 8 meters - 13 meters - 17 meters	X	X	X			P.O.A
MP3090 MP3146	Four Channel Stimulus Multiplexer Box Control Cable -15 meters -27 meters	X	X	X			P.O.A
MP3084-12 MP3084-25	Serial RS 232 Extension Cable -12 meters -25 meters	X	X	X			P.O.A

Optional Kits

Item	Description	Suitable for				Picture	Price
StimLink Kit		EP	SL	SC	OR		
MP3096	StimLink Kit (for BSC)	X	X	X	X		P.O.A

Micropace EPS320 Family Cardiac Stimulators Stimulus Connection Options

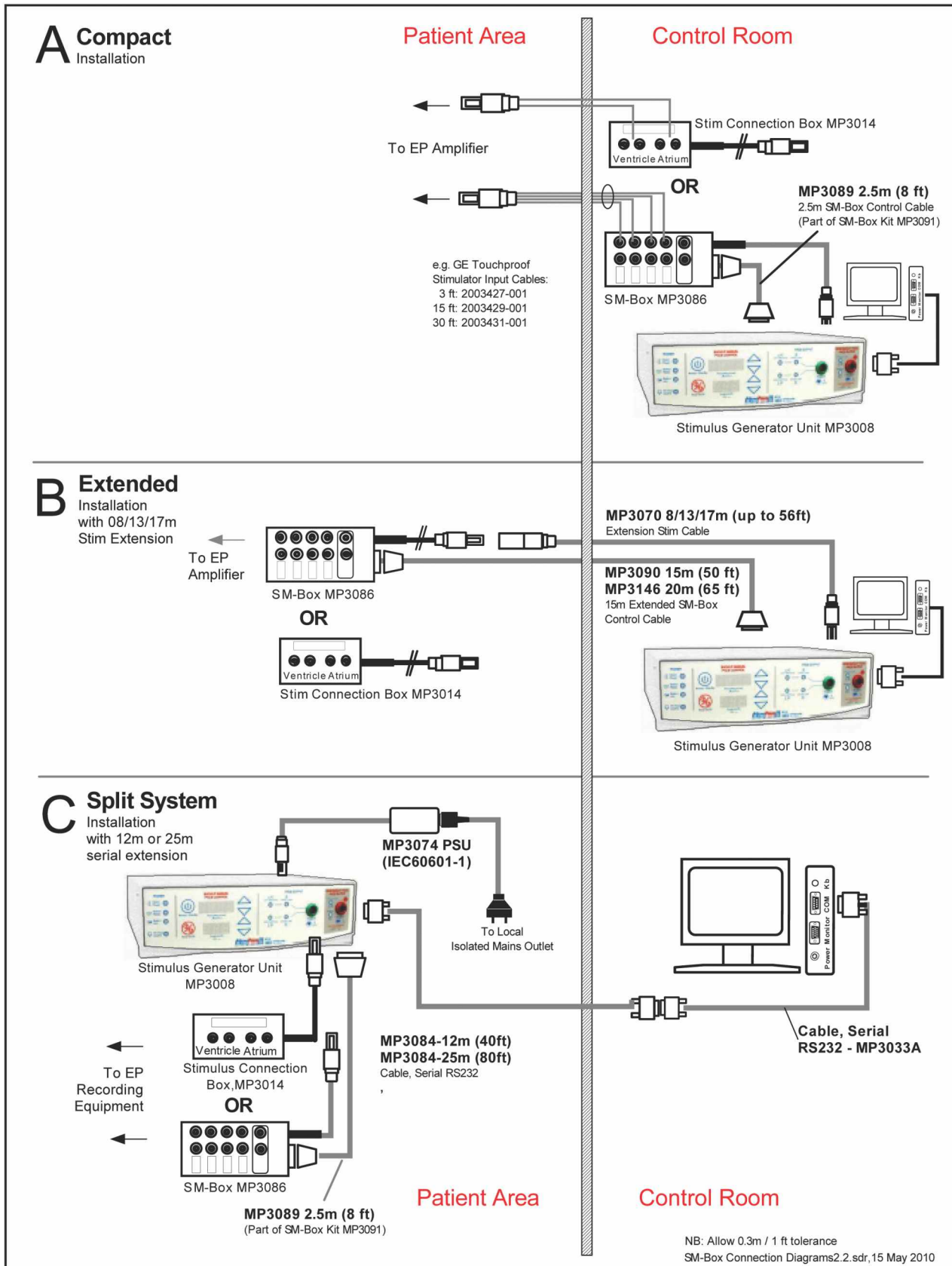

Replacement Parts

Item	Picture	Price
------	---------	-------

Batteries

<ul style="list-style-type: none"> MP3209 12V Sealed Lead Acid Battery (Genesis / Yuasa NP2.3-12FR) Backup SGU Battery 		P.O.A
<ul style="list-style-type: none"> MP3210 9V Lithium Battery (Ultralife U9VL) Emergency SGU Battery 		P.O.A

PSU

<ul style="list-style-type: none"> MP3074 Power Supply for EPS320 SGU 100V- 240V to 15VDC 1.2A Class II 		P.O.A
<ul style="list-style-type: none"> MP3335 Power Supply for Bona Light PC 100-240VAC to 12VDC 5.0A 	 (4 Pin Connector)	P.O.A
<ul style="list-style-type: none"> MP3166 Power Supply for Remote Station AC 100-240V to DC 13V - 3.85A 	 (StimLab ONLY)	P.O.A
<ul style="list-style-type: none"> MP3336 Power Supply for Bona PC AC 100-240V to DC 12V 5A 	 (StimLab ONLY) (4 Pin Connector)	P.O.A
<ul style="list-style-type: none"> MP3363 Power Supply for PC & LCD AC 100-240V to DC 12V 	 (StimCor ONLY)	P.O.A
<ul style="list-style-type: none"> MP3391 Power Supply for VGA Splitter 	 (StimLab ONLY)	P.O.A



Item	Picture	Price
------	---------	-------



Cables

<ul style="list-style-type: none"> MP3088 StimLink™ Mating cable 3m (Serial Modem Cable DB25 to DB9) - 3.0m(10') 		P.O.A
<ul style="list-style-type: none"> MP3087 StimLink™ EP cable 3m Recorder Communications Link-3.0m (10') 		P.O.A
<ul style="list-style-type: none"> MP3034 ECG Signal Cable 6.5mm Phone - Phone 2.5m (8') 		P.O.A
<ul style="list-style-type: none"> MP3109 BNC to Phono Cable 6.5mm -3m (10') 		P.O.A
<ul style="list-style-type: none"> MP3089 Four Channel SM-Box Control Cable DB15 - 2.0m (6.5') 		P.O.A
<ul style="list-style-type: none"> MP3033A Serial RS232 Cable - 2.0m (6.5') 		P.O.A
<ul style="list-style-type: none"> MP3030 Isolated Mains Power IEC320-C14 to C15 Tri-rated 		P.O.A
<ul style="list-style-type: none"> MP3066EU or MP3066US Isolated Mains Power IEC 3 to 2 Pin EU Style 		P.O.A
<ul style="list-style-type: none"> MP3059EU/US Mains power cable for Isolation Transformer 		P.O.A
<ul style="list-style-type: none"> MP3164-17 Stimlab Remote Cable 		P.O.A



For following, MP3070-08 / -13 / -17 refer to Optional Kits: MP3090, MP3146

Replacement Parts

Item	Picture	Price
<h2>Accessories Box</h2>		
<ul style="list-style-type: none"> ■ MP3055-GE-US / EU <p>Accessories Kit* *(Includes SGU Power Supply & other cables)</p> <p>Accessories Box MP3055, Contains</p> <ul style="list-style-type: none"> ■ MP3074 ■ MP3033A ■ MP3335 (PSU) ■ MP3089 (4ch) ■ MP3034 ■ MP3109 ■ MP3351 ■ MP3066 EU / US ■ MP3063 ■ MP3059 EU / US ■ MP3030 <p>Note: MP3063 will not contain fuses (MP3125)</p>	 	P.O.A

Item	Picture	Price
<h2>Brochures</h2>		
<ul style="list-style-type: none"> ■ MP3324 StimLab Brochure GE ■ MP3325 StimLab Brochure BSC ■ MP3396 StimCor Brochure GE ■ MP3397 StimCor Brochure BSC ■ MP3398 EPS320 Brochure GE ■ MP3399 EPS320 Brochure BSC 	  	P.O.A

Transformer		
<ul style="list-style-type: none"> ■ MP3107-Kit Universal Isolation Transformer 300 VA Bracket & Fuses provided 		P.O.A

Stimulus Multiplexer Box		
<ul style="list-style-type: none"> ■ MP3086 Four Channel SM-Box 		P.O.A
<ul style="list-style-type: none"> ■ MP3014 Two Channel Stimulus Connection Box 		P.O.A

Replacement Parts

Item	Picture	Price
SGU		
<ul style="list-style-type: none"> ■ MP3008 Cardiac Stimulator - SGU only *(without power supply) 		P.O.A

Bona Computer Kit		
<ul style="list-style-type: none"> ■ MP3098 MP3098 EPS320/ StimLab/StimCor PC Replacement Kit "Shipped with V4.0 Software only." 		P.O.A

Item	Picture	Price
Miscellaneous		
<ul style="list-style-type: none"> ■ MP3016 Keyboard with labelled keys 		P.O.A
<ul style="list-style-type: none"> ■ MP3063 Installation Kit Test LED's Assorted Adaptors 		P.O.A
<ul style="list-style-type: none"> ■ MP3058 Stimulus Test LED 		P.O.A
<ul style="list-style-type: none"> ■ MP3079 Isolated IEC Power Distribution Board 		P.O.A
<ul style="list-style-type: none"> ■ MP3390 VGA Splitter 2 Ports 		P.O.A

(StimLab & StimCor ONLY)

EPS320B Distributor Code Number

BSC US Distribution Center - UPNs

MP Part Number	BSC UPN - Purchase Order's Item Number	Micropace Description
MP3102B-US	200MP3102	Cardiac Stimulator Bona Light PC
MP3113-B	200MP3113B	ELO LCD Touch Screen
MP3102B-US-J	200MP3319	Cardiac Stimulator Bona Light PC Japanese Config

BSC EU Distribution Center - UPNs

MP Part Number	BSC UPN - Purchase Order's Item Number	Micropace Description
1x MP3102BT-B-EU 1x MP3113-B	MP3102BTBEU 200MP3113B	EPS320 System 2 Channel Touch EU Config - Software 4.00

.xx is the released software version

Arrow

MP Part Number	Arrow Part Numbers	Micropace Description
1x MP3102BT-GE-EU 1x MP3113-GE	7907768 7907773	EPS320 System 4 Channel Touch EU Config
1x MP3102BT-GE-US 1x MP3113-GE	7907764 7907773	EPS320 System 4 Channel Touch US Config
1x MP3102BT-GE-NE 1x MP3113-GE	N/A	EPS320 System 4 Channel Touch EU Config (New Europe)

StimLab Distributor Code Number

BSC US/EU Distribution Center - UPNs

MP Part Number	BSC UPN - Purchase Order's Item Number	Micropace Description
MP3171	200MP3171	StimLab Computer Cabinet
MP3172	200MP3172	StimLab Cardiac Stimulator SGU
MP3173	200MP3173	StimLab Remote Touch Screen
MP3174	200MP3174	StimLab Local Touch Screen

ARROW / GEMS

MP Part Number	ARROW Part Numbers	GEMS Part Numbers	Micropace Description
MP3171	MP3171**GE#71G	2050896-001	StimLab Computer Cabinet
MP3172	MP3172**GE#71G	2050898-001	Cardiac Stimulator SGU Package
MP3173	MP3173**GE#71G	2050899-001	Remote Touch Screen Package
MP3174	MP3174**GE#71G	2050900-001	Local Touch Screen Package

StimCor Distributor Code Number

BSC US/EU Distribution Center - UPNs

MP Part Number	BSC UPN - Purchase Order's Item Number	Micropace Description
MP3343	200MP3343	StimCor Computer Cabinet
MP3344	200MP3344	StimCor Cardiac Stimulator SGU - 2 Chan
MP3172	200MP3172	StimCor / StimLab Cardiac Stimulator SGU - 4 Chan
MP3113-B	Touch Screen	Touch Screen Package

ARROW / GEMS

MP Part Number	ARROW Part Numbers	GEMS Part Numbers	Micropace Description
MP3343	MP3343		StimCor Computer Cabinet
MP3172	MP3172		StimCor- StimLab Computer Cabinet - 4 Chan
MP3113-GE	MP3113-GE		Touch Screen Package

Company Information

Micropace EP Inc. - UNITED STATES

3205 West Warner Ave
Santa Ana, CA 92704, United States

Phone: +1 (714) 258 7025
Email: support@micropaceEP.com

Micropace Pty Ltd - AUSTRALIA

41/159 Arthur Street, Homebush West
NSW2140, Australia

Phone: +61 2 9718 1746
Email: support@micropace.com.au

Distributors Information

Boston Scientific Corporation

300 Boston Scientific Way
Marlborough, MA 01752, USA

Phone: 888-272-1001

GE Healthcare Information Technologies

8200 West Tower Avenue
Milwaukee, WI 53223 USA

Website: <http://www.gehealthcare.com> Phone: +1 (414) 362 2841

Medtronic International Trading Sarl

Route du Molliou 31
1311 Tolochenaz Switzerland

Website: <http://www.medtronic.com>