



EPS320B CARDIAC STIMULATOR

QUICK INSTALLATION GUIDE

Micropace Document Part No. MP3156
Ver 1.8



Rx only

User Configuration Menu password: 'henry' or 4546

Service Configuration Menu password: 'service' or 9897
--

Check for latest Version of EPS320B Installation Manual at <http://www.micropaceep.com/> - Downloads page

Applies to:
EPS320 Software V3.21 SR1, SR2+, V4.0
Two and Four Channel Stimulus Multiplexer Box
Touch Screen

Quick Installation Guide for 4 channel Touch Screen Stimulator

1. **Unpack and verify all components are present as per Packing List.**

- a. MP3113B-X (Touch screen)
- b. MP3102BT-X-X (SGU/Bona PC Carton and cable accessories)

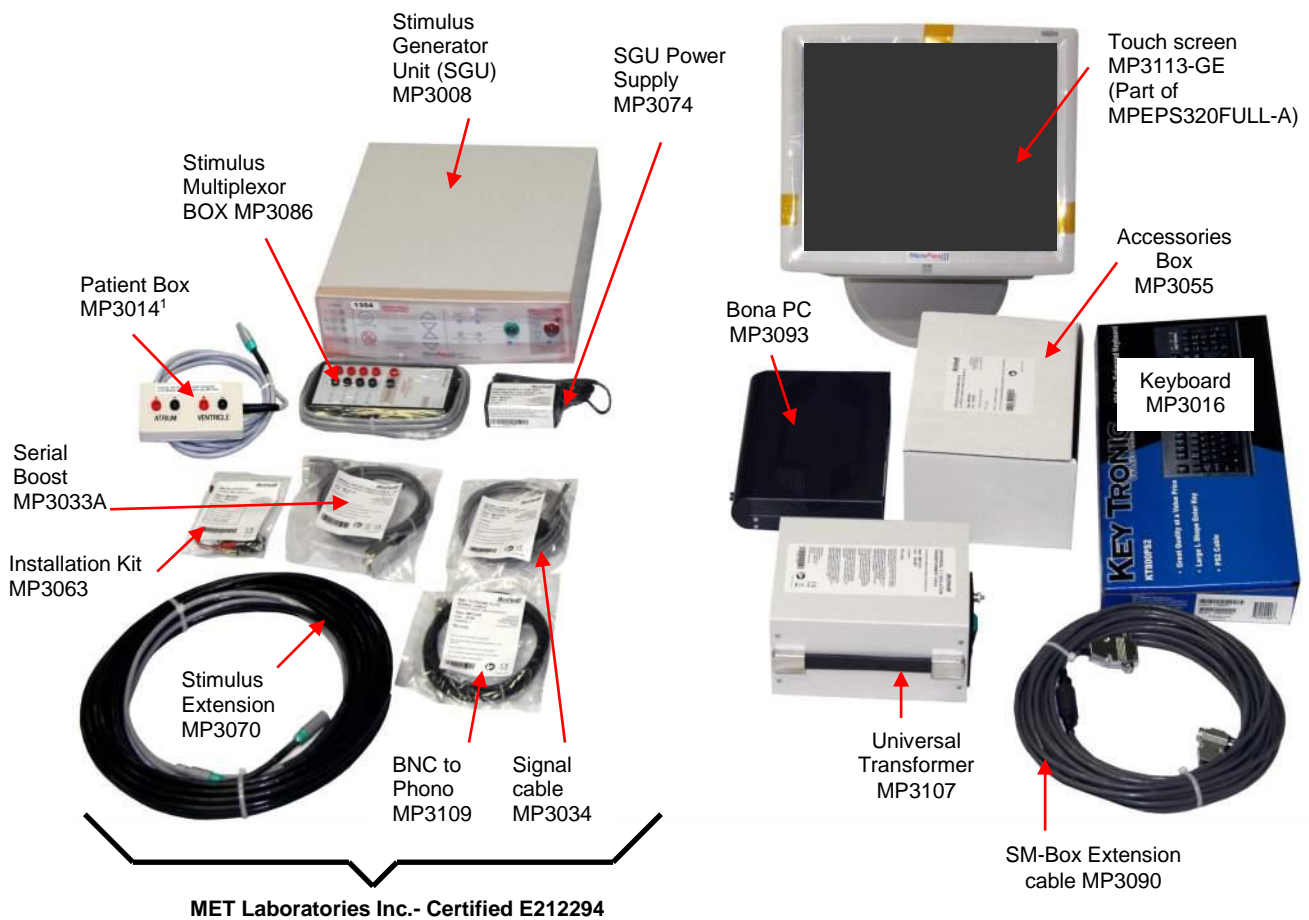

Figure 1 MET Laboratories Inc. approved components shown on the left.

Note 1 : Optional part, not a component of MP320BFULL.

NRTL Listed equipment approved by MET Registration Number E212294		
Item	Part No	Description
1	MP3008	Stimulus Generator Unit (SGU)
2	MP3074	Power Supply GTM21089-1815-T2 (PSU1)
3	MP3109	BNC to Phone Signal Cable
4	MP3033A	Serial Boost RS232 Cable (2m)
5	MP3034	Signal cable with Phone Plugs
6	MP3063	Installation Kit Incl. (i) 4X Fuses T1.25A 250V, (ii) LED Tester MP3058
7	MP3086	Stimulus Multiplexer BOX
8	MP3070	Stimulus Extension cable
Optional approved parts		
9	MP3014	Stimulus Connection Box
10	MP3084	RS232 Extension Cable 25 Meters

Table 1 NRTL approved equipment

2 You will be Interconnect the five main components according to the below overview and subsequent detailed instruction steps 2 – 4. Ensure all components have adequate ventilation.

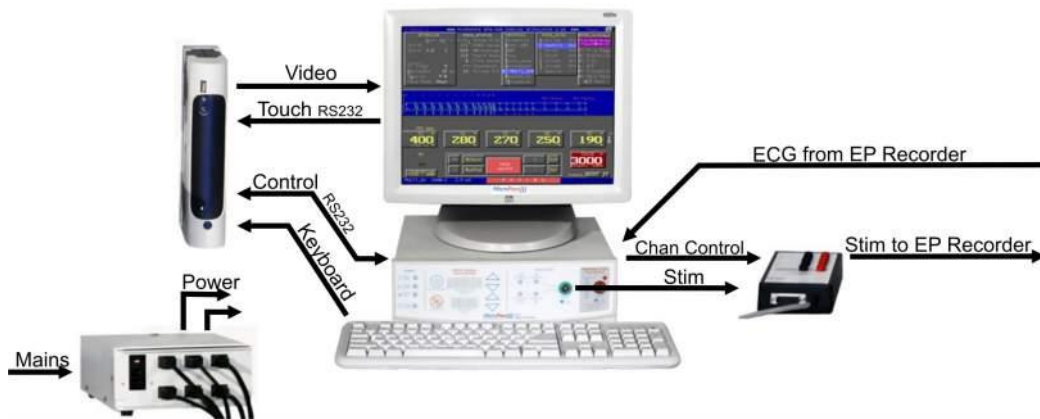
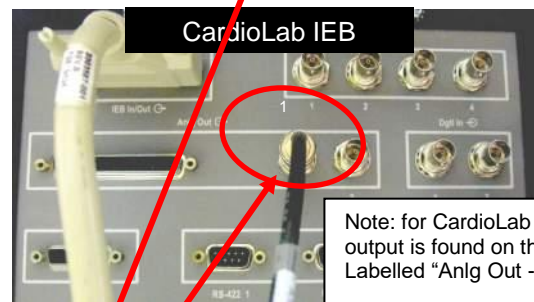
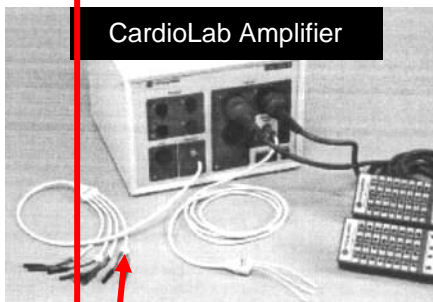

Figure 2 Overview of Stimulator Connections

3

Lay out and connect Stimulus cabling, (under ground if required) between EPS320 Stimulus Generator Unit (SGU) and EP Amplifier (LS Pro and CardioLab recorders shown):



Note: for CardioLab II, ECG output is found on the IEB Labelled "Anlg Out - 1".

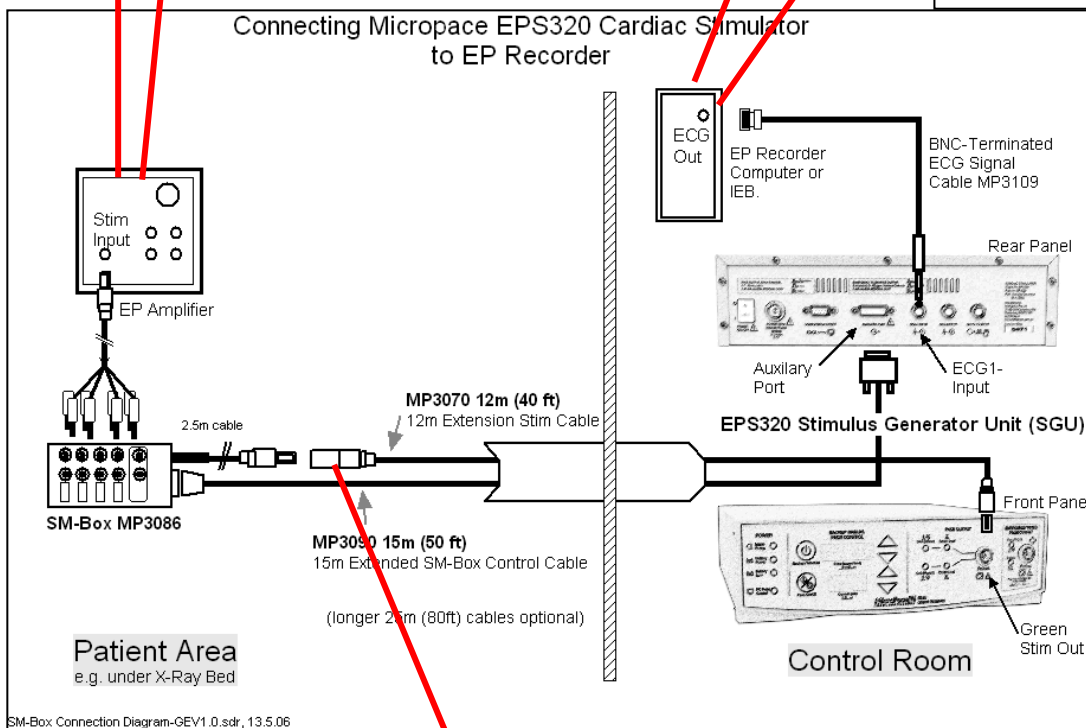

Warning: To prevent patient micro-electrocutation through capacitively coupled leakage currents, MP3070 and MP3126 cable installation must be (i) appropriately insulated and separated from any nearby mains wiring to prevent injection of mains voltage through broken insulation, (ii) must not be installed next to mains voltage-energised cables and (iii) should not be installed within grounded conduits. Installation should be acceptance tested by biomedical engineer for Patient Applied Part, Class CF device.

Note that when longer (>15m) length of Extension Stim Cable is required, it is preferable to place the SGU in the operating room on top of the Amplifier under the patient table and use a long 80'/25m serial cable MP3084-25 to interconnect PC with SGU. This will reduce noise and ground leakage currents in the whole installation.

- 4 Connect all power supplies to Isolation transformer and interconnect SGU and PC serial ports with MP3033A.

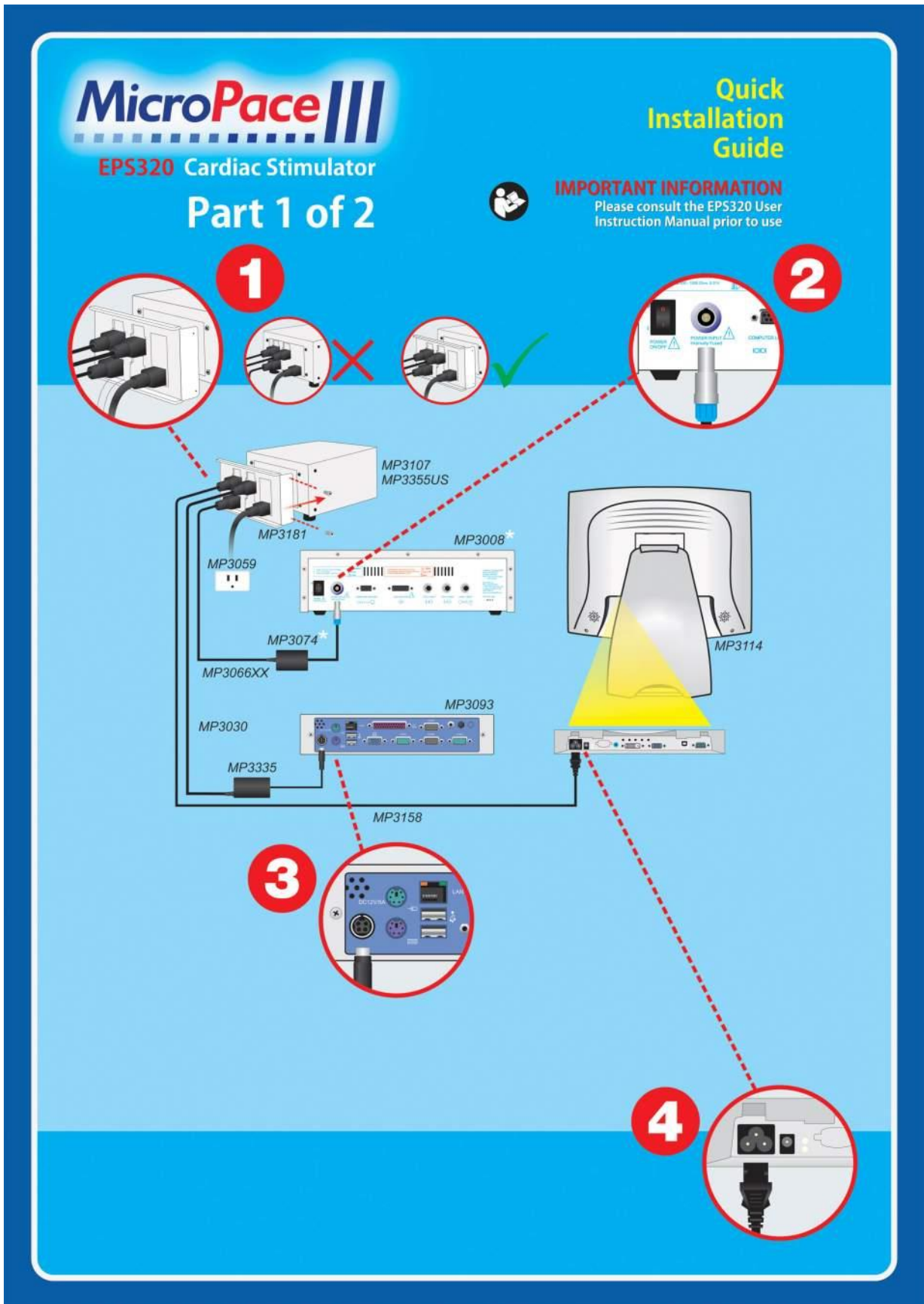

5 Interconnect Eps320b Computer, LCD Display And SGU:

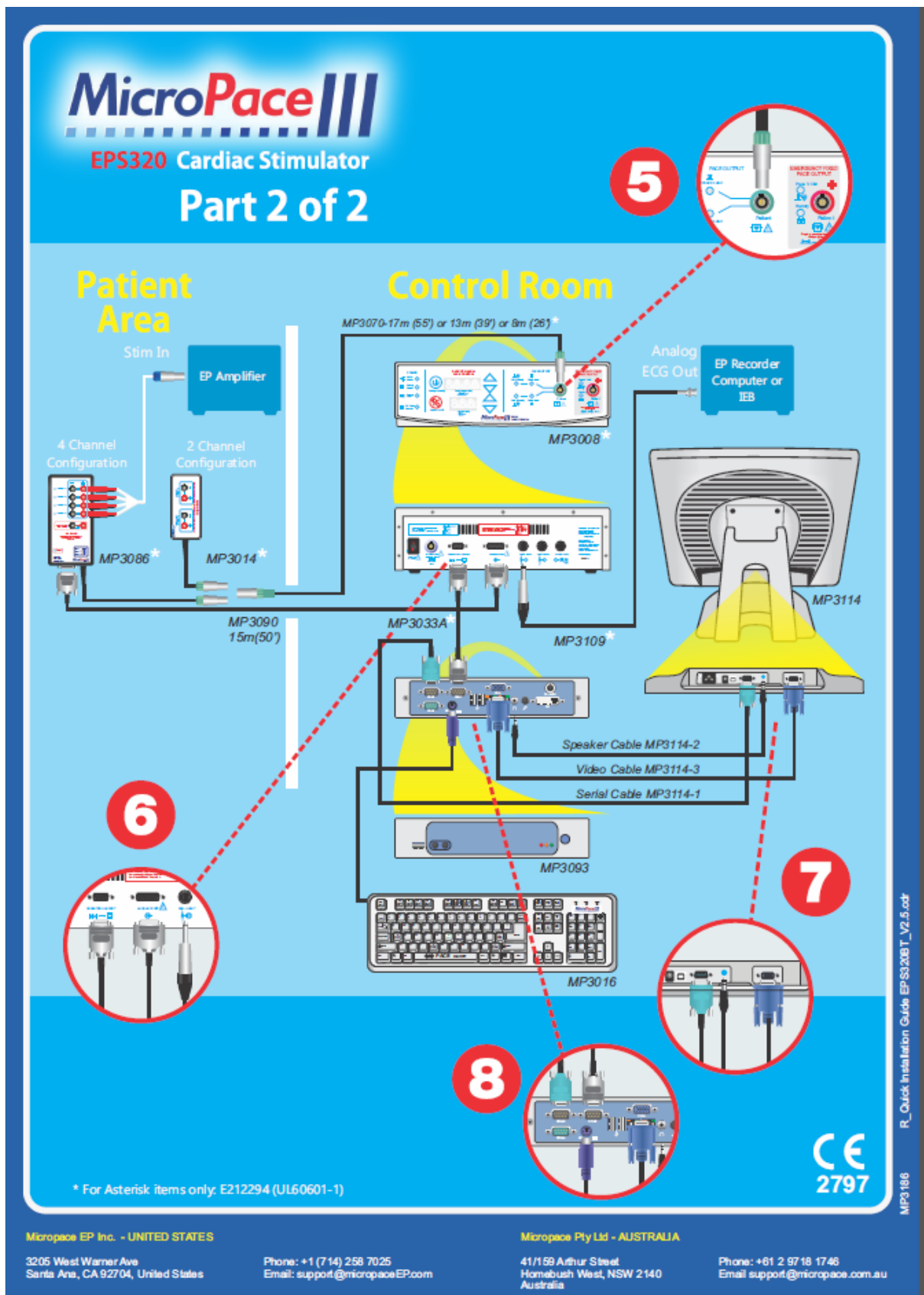

6 Now Set up the computer:

- a. Switch on (i) Isolation transformer, (ii) Bona PC (push front button once), (iii) LCD Display (on the side) and (iv) SGU at the rear. Allow system to boot up.
- b. When prompted respond that you are the distributor (to avoid having the License agreement shown to you)
- c. If you have an EU version, you will be offered a menu to chose an interface language.
- d. When prompted to calibrate screen, touch screen in the places indicated by crosses from the seated position and the same eye level as the customer will use, using the stylus.



- e. You will now see the Mains Stimulator Screen as below:
- f. The stimulator software will already be configured for the hardware setup you purchased – touch screen, four channels and one external ECG.



7

Verify System (use checklist on last page):

- a. **Verify Isolated Mains.** Visually verify that all EPS320B components – PC, SGU, LCD Screen, are connected to a Medical Grade Mains Isolation Transformer e.g. MP3107.
- b. **Clean launch.** Verify that SGU and Software launch without errors.
- c. **Test Pacing channels.** Insert Stimulus Test LED, MP3058 (from the Installation Kit in the Accessories Box)) into the EP Recording Equipment's bedside catheter input modules (CIM's) - Block A. Configure the EP Recording Equipment to stimulate those outputs from the Chan 1 Atrial stimulation channel. Set current to 25mA and commence pacing into the Atrium.
The Stimulus Test LED should light with pacing (Yellow light indicates that the stimulus pulse is positive at the red connector and negative at the black one while Red light indicates the opposite or wrong polarity).
Repeat pacing test for all four channels, using other 3 CIM Blocks. Similarly verify that Emergency Fixed Rate Pacing (red output socket) stimulates into Ventricle / Chan 2.
- d. **Verify ECG sensing.** Connect ECG simulator to EP recorder surface leads, select one channel to sense from and verify that EPS320B Stimulator displays the ECG on the screen (if you don't have a simulator, create some noise on channel by touching the electrode).
- e. **Safety Acceptance.** Finally, organise Biomedical engineering to perform acceptance test the entire installed system according to the health facilities' procedure's.
- f. **Troubleshooting.** If there are problems, refer to the troubleshooting section below, in the Installation Manual, the User Instruction Manual or the Micropace Connect iPad Application.
- g. **Make a record.** Make a record of the verified installation and sign and date according to your company's quality system and file as required.

8 Train Customer

- a. **Customize Stimulator settings.** Sit down with the responsible customer – chief technician or physician and set up various defaults for the Stimulator – default S1 values in protocols, minimum S1 and Sx values in Configuration menu. Save defaults into one or more of the Setups.
- b. **Demonstrate User Instruction Manual.** Inform the electrophysiologist and technician of the safety features of the stimulator and direct them to the relevant sections in the User Instruction Manual where safety warnings are listed.
- c. **Demonstrate Help feature,** (hotkey 'h') wherever they are in the program, including diagrams. Explain Safety Diagram as an aid to safety items below. Help/ 3.Diagrams/ 6.Safety Guide is a useful diagram for this.
- d. **Demonstrate F12 Emergency Pacing key.** While Stimulator is in normal PC control mode and in any protocol, press F12 / Red First Aid cross symbol on keyboard to demonstrate Emergency Pace protocol whereby both channels are immediately paced.
- e. **Demonstrate Manual Backup Pacing Mode** - Demonstrate this safety mode (in cases of PC failure) by pressing the 'BACKUP ENABLE' button on the Stimulator) (or disconnecting Serial Cable MP3033A. Press 'PACE ON/OFF' button to pace. Adjust 'Interval' with up/down arrow buttons. Pacing is always into both channels. Remind user that if Ep Recorder is not working, they MUST plug the pacing leads into the Bypass Stim Outputs on the recorder's catheter input modules (CIM's). Hit [Enter] on the computer to re-enter PC Control mode.
- f. **Demonstrate Fixed Rate Emergency Pacing Mode.** Instruct the User that should the SGU itself fail, they can use this feature. Connect Stimulus Test LED, MP3058 to Stimulator Output on the Ventricle / Chan 2 output and on the SGU front panel, remove the Stimulus Connection Box's MP3014 green connector from the SGU's green Pace Output socket and insert it into its red Emergency Fixed Pace Output socket. The self-contained emergency circuit will commence pacing at 100 pulses per minute, 5mA and 2ms width (it detects presence of load resistance on the output and commences pacing automatically).

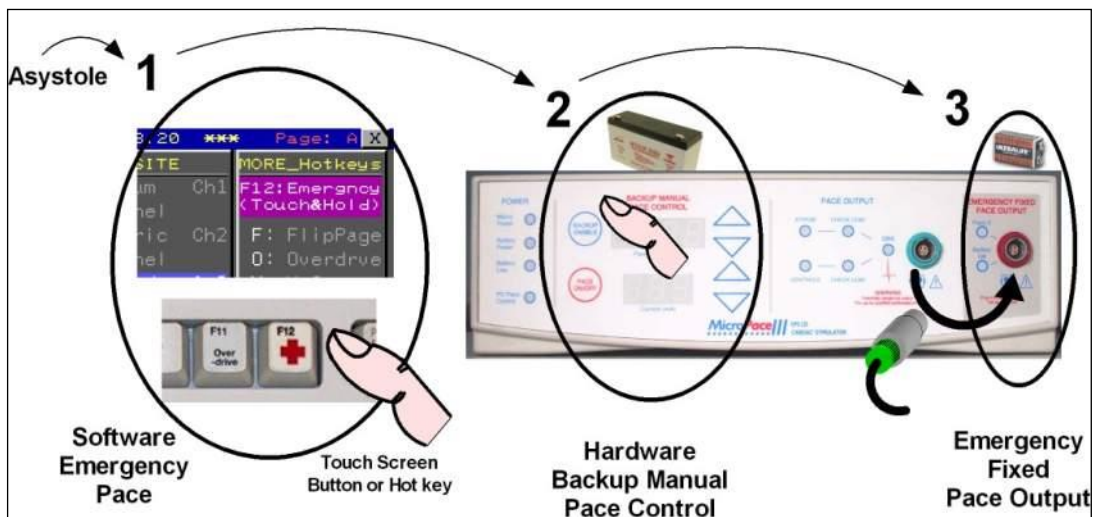

9 Make record.

Make a record of the verified installation, date and sign and lodge record according to your company's quality system requirements. Installation is now finished.

1

Troubleshooting

1. System problems

#	Problem	Explanation	Suggested action
1	No External ECG on EPS320B screen, patient or simulator is connected.	No external ECG signal connected to SGU ECG1 Input, Or SGU Fault	<ol style="list-style-type: none"> 1. Select Alt-I, i.e. sense from catheter tip of paced electrode – this should always show an ECG if adequately placed in the heart. 2. If using External ECG inputs, verify connection and settings on EP EP Recording Equipment 3. Verify that ECG is indeed connected into the ECG inputs, and not the Sync Output on the rear of the SGU.

2. Stimulus Generator Error Message on Front Display.

Error Message	Error Name	Explanation	Suggested action
b,A,t,t E,r,r	Battery Error	Internal Backup Battery is depleted due to operation or prolonged storage without external power connected. Stimulus Generator Unit(SGU) can function on external power only.	Reconnect external power and press Backup Enable button. SGU may be used while connected to external power. Allow unit to charge for 6 hours. If error persists after recharge then 12V Battery is faulty.
b,A,t,t ,L,O	Battery Low	Backup Battery charge is low due to operation or prolonged storage without external power connected. Stimulus Generator Unit(SGU) will function normally, but requires recharging.	Reconnect external power and press Backup Enable button. SGU may be used while connected to external power. Allow unit to charge for 6 hours. If error persists after recharge then 12V Battery is faulty.
E,b,a,t E,r,r	Emerg. Batt Error	Emergency Battery self test failed indicating 9V LiMn battery is depleted. This battery has shelf life of 10 years, so this error indicates either excessive use of Emergency Pacing or early depletion of battery due to faulty battery or faulty circuit.	Contact the Distributor, Micropace or your biomedical engineering department to have Emergency Pace Battery replaced.

Micropace Installation Checklist

The following checklist is to be performed after installation EPS320B and before first 'live' EP case. Any exceptions / failures must be signed off by Clinical specialist or engineer prior to use on patients.

Item	Test Method	Expected	Observed	P/F
1.Mains Isolation	Visually verify that all EPS320B components – PC, SGU, LCD Screen, are connected to a Medical Grade Mains Isolation Transformer e.g. MP3107, not wall socket.	All components plugged into Isolation Transformer.		
2.SGU POST	Power on SGU and observe all LED's during POST	All LED's light momentarily (except Emergency Fixed Rate Pace) and no errors appear on SGU display.		
3.Software Launches OK	Observe EPS320 Software launches without error messages.	SGU Main screen appears, no error messages		
4.Stimulation path & Polarity OK.	Connect EPS320B to EP Recorder, both configured for Ventricle/Chan 2 to stimulate at 20mA 10ms S1: 300ms; Insert Yellow/Red Test LED (MP3058) into breakout box where stimulus expected red to +ve. Start pacing and verify yellow LED lights with each pulse. If red LED lights then polarity is incorrect.	Yellow LED flashes with each stimulus.		
5.Emergency Fixed Rate Pacing OK	With a Test LED across the Ventricle/Chan2 output s in 4. above, change over stimulus cable connection to the SGU from Pace Output green socket) to Emergency Fixed Rate Pacing Output (red socket). Observe pacing. Restore stimulus cable to green 'Stimulus Output' connector.	Pacing sound is emitted and yellow LED lights at approx. $100 \pm 20\%$ ppm. Test LED pulses light. 'Battery' indicator lights after about 4s.		
6.ECG Visible	Connect ECG simulator to one channel on the EP Recorder, select it for ECG sensing and verify that EPS320B displays ECG on its screen. If no ECG simulator available, connect one pin of Test LED and get someone to touch the other pin to create an unbalanced noise source.	ECG / noise is seen on EPS320B screen.		
7. Biomed Engineering approval	Health facility's Biomedical Engineering Dept. is generally required to test and accept the installed system for electrical safety; ensure that this has been done.	Biomed Engineering acceptance verified.		